

SHADE SAIL CATALOGUE

EXPECT QUALITY- EXPECT SERVICE - EXPECT VALUE



WHAT OUR CUSTOMERS SAY ABOUT US:

Miami Stainless has over many years given me top class service. They always have the stock I need and is despatched promptly. The staff are very helpful and know their products well.

Neil Harding

I stumbled into this organisation while looking for steel brackets for my roof. First of all they were much cheaper but secondly I'm blown away I've received my item within 24 hours of placing my order. I'm in WA and they're based in QLD! You all rock! I'll be going back for any of my steel needs

Jay Darji

Over 200 Five Stars Reviews

NOTE:

All sizes in this Catalogue are mm
All Break Loads (BL) in this Catalogue are Kg
Turnbuckle Pictures are ProRig Products

TO ORDER:

Visit www.miamistainless.com.au
Call 1800 022 122
Email info@miamistainless.com.au



SCAN HERE
FOR MORE

EXPECT QUALITY- EXPECT SERVICE - EXPECT VALUE



PRO RIG

ECON

DEE RING

Scan QR code to check pricing.
Login to your account to view your trade price.

Dee Ring Thimble AISI 316/304

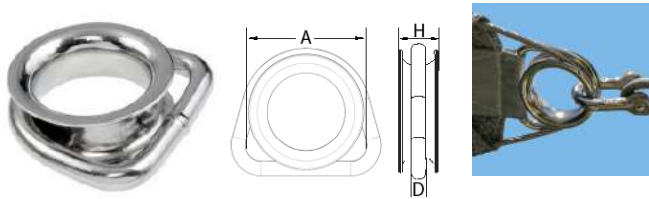

Code	Size	Suits Wire	D	A	H	BL
S3257-0630	6 x 30	Up to 5mm	6	30	13	1800
S3257-0650	6 x 50	Up to 5mm	6	50	16	1800
S3257-0850	8 x 50	Up to 6mm	8	50	19	2800
S3257-1065	10 x 65	Up to 10mm	10	65	24	5000



Please specify ProRig or Econ range when ordering. ProRig AISI 304, Econ AISI 316

Dee Ring AISI 316/304

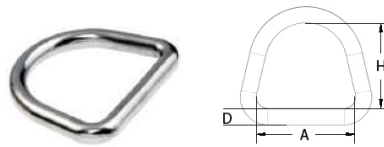

Code	Size	Grade	D	A	H	BL
S325-0315304	3 x 15	304	3	15	12.8	265
S325-0320	3 x 20	316	3	20	18	400
S325-0320304	3 x 20	304	3	20	17	600
S325-0340	3 x 40	316	3	40	38	255
S325-0425	4 x 25	316	4	25	22	800
S325-0425304	4 x 25	304	4	25	22	800
S325-0525	5 x 25	316	5	25	22	1000
S325-0540	5 x 40	316	5	40	32.6	1000
S325-0640	6 x 40	316	6	40	35.9	1800
S325-0640304	6 x 40	304	6	40	36.4	1050
S325-0650	6 x 50	316	6	50	43	1800
S325-0650304	6 x 50	304	6	50	47.8	1050
S325-0845	8 x 45	316	8	45	35.7	2800
S325-0850	8 x 50	316	8	50	44	2800
S325-0850304	8 x 50	304	8	50	46.6	2800
S325-1065304	10 x 65	304	10	65	54.9	5000



Please specify grade when ordering AISI 304 or AISI 316

Ezi Hold Dee Ring AISI 316

Patent Protected Registered Design®

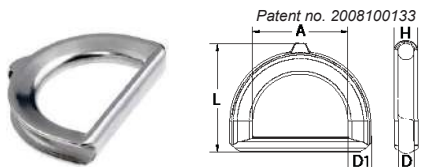

Code	Size	Suits Wire	D	D1	A	L	H	BL
S3259-55OPR	5 x 50	Up to 5mm	5	9	51	55	8	3240
S3259-85OPR	8 x 50	Up to 8mm	8	13	52	62	12	7600



Wire Support Dee Ring AISI 316

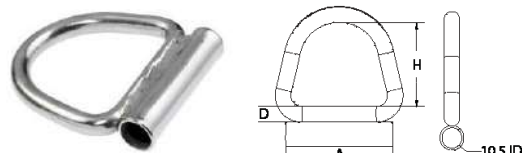

Code	Size	D	A	H	BL	ID
S325WS-850	8 x 50	8	57	43	2800	10.5

Suits wire up to 8mm.



Ezi Hold Dee Ring With Eye AISI 316

Patent Protected Registered Design®

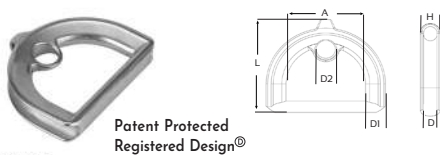

Code	Size	Suits Wire	D	D1	D2	A	L	H	BL
S3259E-550	5 x 50	Up to 5mm	5	9	10.5	51	58	8	3240
S3259E-850	8 x 50	Up to 8mm	8	13	12.5	52	65	12	7600



Ezi-Hold Dee Ring With Pipe AISI 316

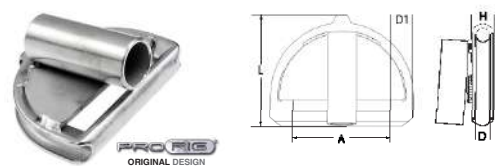

Code	Size	Suits Wire	D	D1	A	L	H	Tube I.D
S3259P-55OPR	5 x 50	Up to 5mm	6	9	50	55	8	12mm
S3259P-85OPR	8 x 50	Up to 8mm	8	13	50	62	12	16mm

Toggle bolts on page 3



Ezi Hold Dee Ring With Eye And Bar AISI 316

PRO RIG ORIGINAL DESIGN



Patent Protected Registered Design®

Code	Size	Fits Wire Rope	Fits Dee Shackle Up To Size	Fits Turnbuckle Jaw Jaw	D	D1	D2	A	L	H	W	BL
S3259EE-0450	4 x 50	Up to 4mm	10mm	6, 8, 10 & 12mm	5	12.5	21.5	51	55	8	4	3240
S3259EE-0650	6 x 50	Up to 6mm	12mm	10 & 12mm	6.60	12.5	24.5	52	59	11	4	7600



ProRig Ezi Hook 12mm with 8mm Pin AISI 316



Code	D	DI	H	A	L	B	BL
S3260-12PR	12.5	12.9	31.4	17.6	56	15.3	5000

The Ezi Hook will be available in Q3 2026.

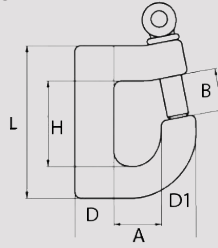

Dee Ring Thimble with Eye AISI 316

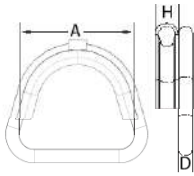

Code	Size	Suits Wire	D	A	H	BL
S3258-650	6 x 50	5mm	6	50	15	1800
S3258-850	8 x 50	6mm	8	50	18	2800



Triangle AISI 316/304

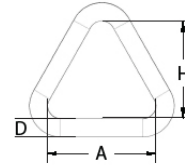

Code	Size	Grade	D	A	H	BL
S325T-0425	4 x 25	316	4	25	23	460
S325T-0530	5 x 30	316	5	30	25.7	710
S325T-0632	6 x 32	316	6	39	37	2000
S325T-0650	6 x 50	316	6	50	46	2000
S325T-0850	8 x 50	316	8	50	45	2800
S325T-1065304	10 x 65	304	10	65	57.4	5000



Dee Ring with Crossbar AISI 304

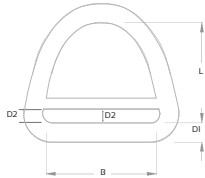

Code	Size	Grade	B	D1	D2	L	BL
S3251-05050	5 x 50	304	52	5	4.2	43	1000
S3251-06050	6 x 50	304	50	6	4.3	43	1800
S3251-08050	8 x 50	304	50	8	5.5	43	2800

Square Ring AISI 316

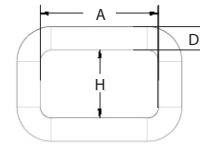

Code	Size	D	A	H	BL
S4490-0525	5 x 25	5	25	15	1000

Typical safety factor for Maximum Working Load (MWL) is 1/4 of Break Load (BL)

BUCKLES

Slide Buckle AISI 316

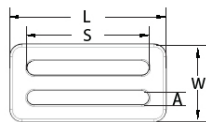

Code	Size	W	L	S	A
S3181-25	25	17	32	25	3.6
S3181-50	50	32	64	50	6

Cam Buckle AISI 316

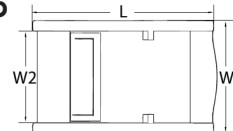

Code	Size	L	W	W2
S3108-25	25	53	32.5	26
S3108-25S	25	43	30	26

OTHER SAIL CORNER FITTINGS

Round Ring AISI 316/304

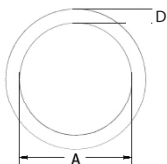

Code	Size	Grade	D	A	BL
S1717-03020	3 x 20	316	3	20	650
S1717-04025	4 x 25	316	4	25	1000
S1717-05020	5 x 20	316	5	20	1500
S1717-05025	5 x 25	316	5	25	2000
S1717-05035	5 x 35	316	5	35	2000
S1717-05040	5 x 40	316	5	40	2000
S1717-06030	6 x 35	316	6	30	2700
S1717-06035	6 x 35	316	6	35	2700
S1717-06040	6 x 40	316	6	40	2700
S1717-06050	6 x 50	316	6	50	2700
S1717-08030	8 x 30	316	8	30	5000
S1717-08050	8 x 50	316	8	50	5000
S1717-08055	8 x 55	316	8	55	5000
S1717-08075304	8 x 75	304	8	75	5000
S1717-10075	10 x 75	316	10	75	8500
S1717-12080	12 x 80	316	12	80	10000
S1717-12100	12 x 100	316	12	100	10000
S1717-12120	12 x 120	316	12	120	10000
S1717-13100	13 x 100	316	13	100	11500



Round Ring with Centre Crossbar AISI 316

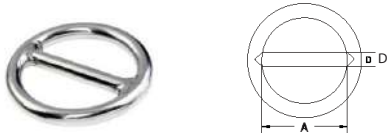

Code	Size	D	A	BL
S3171-06038	6 x 38	6	50	2700
S3171-08050	8 x 50	8	50	5000
S3171-12080	12 x 80	12	90	10000



Round Thimble AISI 316/304

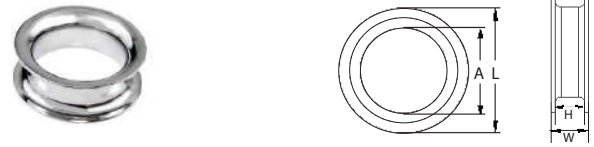

Code	Size	W	H	A	L	Grade
S234R-1150	11 x 50	11	5.5	34	50	316
S234R-1550304	15.5 x 50	15.5	10	35	50	304
S234R-1850304	18 x 50	18	15	35	50	304



CORNER DISC & ACCESSORIES

Scan QR code to check pricing.
Login to your account to view your trade price.

Corner Disc with Welded Tube



Aluminium sandwich plate design with high quality AISI 316

Tube also sold separately
Product code: CD-090-Tubebolt-1020

Code	Ømm	Material	Suits Wire	Tube I.D
CD-090	90	Aluminium	Up to 6mm	12mm



Corner Disc with Tube AISI 316



Code	Ømm	Tube I.D
CD-150PR	150	21.3 mm

- ✓ High-Density polyethylene Inside discs to stop cables from grabbing
- ✓ Adjustable angle on tube bolt to allow for tensioning from different angles
- ✓ Longer length tube to help protect threads when tensioning
- ✓ Tube also sold separately
Product code: CD-150PR-Tubebolt-1020

Variable Termination Discs AISI 316



Code	Ømm	Tube I.D
CD-VTD	150	12mm



(For vinyl shade corners)
Price includes 2 discs.

150mm diameter variable termination discs are a sandwich plate design that adjusts to almost any required angle of the fabric corner.

The 12mm ID tube allows for tension adjustment of each individual side with 12mm threaded terminals. To clamp the two discs use a M10 hex head screws and hex nuts or nylock hex nuts.

TOGGLE BOLTS

Toggle Bolt Head AISI 316



Threaded Rod Page 11



Threadlocking Compound Page 5

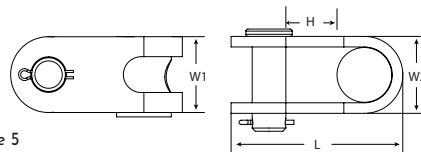

Old model. Welding service available on request.

Code	Thread	Pin	H	L	W1	W2
S3125H-12	M12	12	26	59	26	28
S3125H-20	M20	20	41	115	50	23

New model. Welding service available on request.

Code	Thread	Pin	H	L	W1	W2
S3125H-16	M16	16	33	94	45	34



Use toggle bolt heads in conjunction with stainless threaded rod and a thread locking compound to make your own toggle bolt at any length up to 1 metre. The wide jaw is designed to fit over thicker corner discs and anchor points.

Toggle Bolt AISI 316

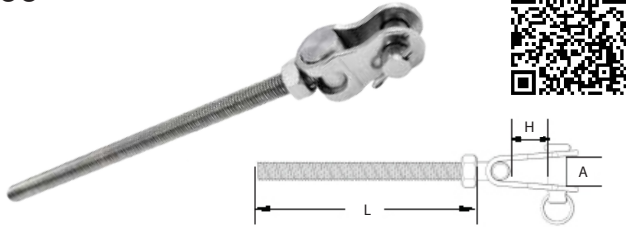

Code	Thread	Pin	A	H	L	BL
S3125-10150	M10	10	20	26	150	2500
S3125-12150	M12	12	20	26	150	3700
S3125-12200	M12	12	20	26	200	3700
S3125-12221	M12	12	16	17	221	5000
S3125-16150	M16	16	16	42	150	6950
S3125-16222	M16	16	16	22	222	8000
S3125-16500*	M16	16	27	33	500	6950

In some situations, toggle bolts can be used as an alternative to turnbuckles on shade sail corners.

*S3125-16500 - New Toggle Bolt Head

M12 x 500mm coming soon

TURNBUCKLES



Turnbuckle Jaw/Jaw AISI 316

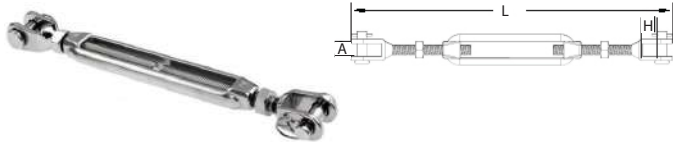

Code	Thread	A	H	L-Min	L-Max	BL
S311J-05	M5	7	9	120	160	750
S311J-06	M6	8	10	150	200	1400
S311J-08	M8	11	11	195	265	2200
S311J-10	M10	12	12	243	340	3450
S311J-12	M12	16	21	320	455	5000
S311J-14	M14	15	21	310	440	6400
S311J-16	M16	17	27	368	550	8000

Please specify ProRig or Econ range when ordering.

Scan QR code to check pricing.

Login to your account to view your trade price.

Bottlescrew Jaw/Jaw AISI 316

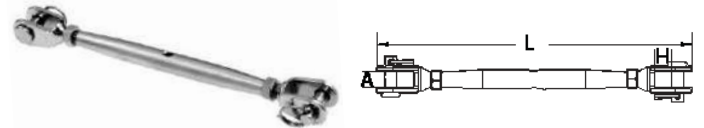

Code	Thread	A	H	L-Min	L-Max	BL
S312J-05	M5	7	9	132	210	750
S312J-06	M6	8	10	151	234	1400
S312J-08	M8	11	10	178	276	2200
S312J-10	M10	11.5	17	220	332	3450
S312J-12	M12	14	27	270	413	5000
S312J-16	M16	20	25	347	509	8000
S312J-20	M20	20	28	390	562	10500
S312J-24	M24	30.2	41	490	705	14500

Please specify ProRig or Econ range when ordering.

Turnbuckle Hook/Eye AISI 316

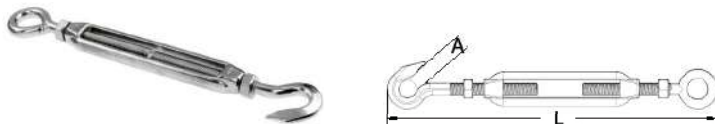

Code	Thread	A	L-Min	L-Max	BL
S311HE-05	M5	5	120	160	130
S311HE-06	M6	6	150	220	350
S311HE-08	M8	8	225	290	650
S311HE-10	M10	10	255	350	800
S311HE-12	M12	12	320	470	1400

Please specify ProRig or Econ range when ordering.

Turnbuckle Eye/Eye AISI 316

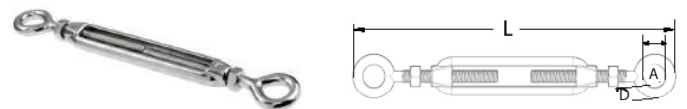

Code	Thread	A	D	L-Min	L-Max	BL
S311E-04	M4	8	4	120	170	475
S311E-05	M5	8	5	120	170	680
S311E-06	M6	12	6	150	220	1500
S311E-08	M8	13	8	210	300	2300
S311E-10	M10	16	9	245	350	3100
S311E-12	M12	20	10	315	470	4400
S311E-16	M16	25	16	400	610	8100

Please specify ProRig or Econ range when ordering.

Turnbuckle Hook/Hook AISI 316

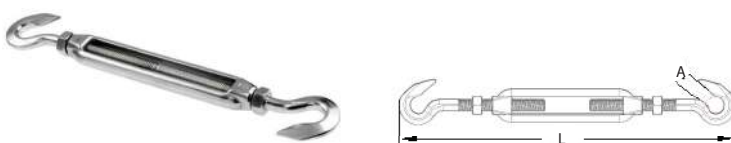

Code	Thread	A	L-Min	L-Max	BL
S311H-05	M5	7	120	160	130
S311H-06	M6	9	155	220	350
S311H-08	M8	10	225	290	650
S311H-10	M10	13	255	350	800
S311H-12	M12	15	320	470	1400

Please specify ProRig or Econ range when ordering.

Typical safety factor for Maximum Working Load (MWL) is 1/4 of Break Load (BL). All BL on this page are based on ProRig products.

LOCTITE, NICKEL & MOLYTEC RANGE

Loctite Anti-Seize Stick



Code	Description
ANTI-20	Anti-Seize Stick

Always use an anti-seize product on turnbuckle threads to minimise binding.

Nickel Anti-Seize Lubricant Tube



Code	Size
ANTI-065NT	65g

Nickel Anti-Seize Lubricant Aerosol



Code	Size
ANTI-300NT	300g

IMPORTANT: This product is shipped by road only.

Nickel Anti-Seize Lubricant Tin



Code	Size
ANTI-225NT	225g

Ultraloc Threadlocking Compound



Code	Size
THREADLOC-10	10ml

Ultraloc Threadlocking Compound



Code	Size
THREADLOC-50	50ml

Scan QR code to check pricing.
Login to your account to view your trade price.

SHACKLES

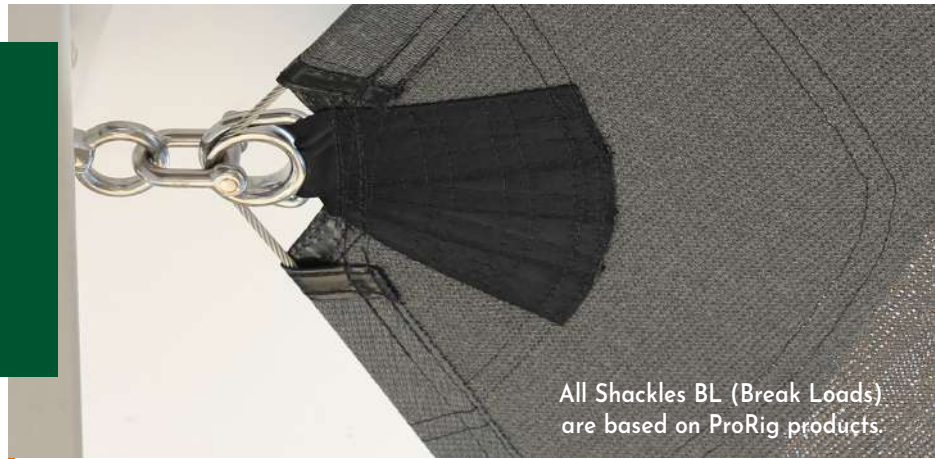

All Shackles BL (Break Loads) are based on ProRig products.

Dee Shackle Cast AISI 316

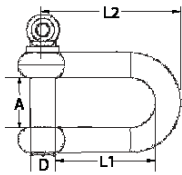

Code	Size	D	A	L1	L2	BL
S360-05	5	5	11	17	25	1000
S360-07	7	7	14	24	42	2000
S360-16	16	16	32	56	95	8800
S360-19	19	19	38	66	110	10000



Dee Shackle AISI 316 - Forged

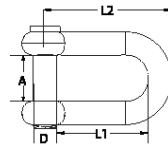

Code	Size	D	A	L1	L2	BL
S360F-05	5	5	11	18	25	1800
S360F-06	6	6	12	21	35	1850
S360F-07	7	7	14	25	35	1850
S360F-08	8	8	16	28	48	3500
S360F-10	10	10	20	35	59	5440
S360F-12	12	12	25	42	73	8000
S360F-16	16	16	32	54	80	10000



Forged shackles have a higher BL compared to standard cast shackles.

Bow Shackle AISI 316 (Anchor, Forged)

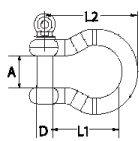

Code	Size	D	A	L1	L2	BL
S370F-05	5	5	11	19.5	26.5	1250
S370F-06	6	6	12.5	31	40.5	2000
S370F-08	8	8	17	37.5	49	3500
S370F-10	10	10	21	47	61	5520
S370F-12	12	12	25	58	77	7360



Forged shackles have a higher BL compared to standard cast shackles

Bow Shackle Cast AISI 316 (Anchor)

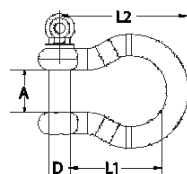

Code	Size	D	A	L1	L2	BL
S370-05	5	5	10.5	21	33	1200
S370-16	16	16	32	74	112	9200
S370-22	22	22	43	98	150	18000



Long Dee Shackle AISI 316



Code	Size	D	A	L1	L2	BL
S362-06	6	6	12	45.5	55.5	1700
S362-08	8	8	17	60	72	2500
S362-10	10	10	22	75	90	3500
S362-12	12	12	26	90	108	5400



Please specify ProRig (Cast) or Econ (Forged) range when ordering. Breakloads shown applies to ProRig only.

Bow (Anchor) Shackle Bolt Pin AISI 316

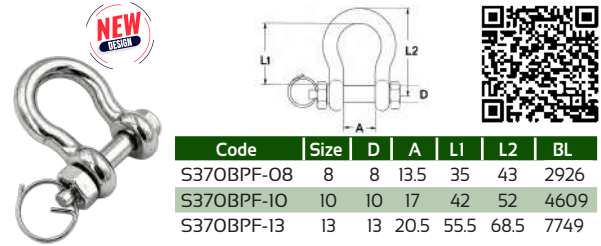

Code	Size	D	A	L1	L2	BL
S370BPF-08	8	8	13.5	35	43	2926
S370BPF-10	10	10	17	42	52	4609
S370BPF-13	13	13	20.5	55.5	68.5	7749



Twisted Shackle AISI 316

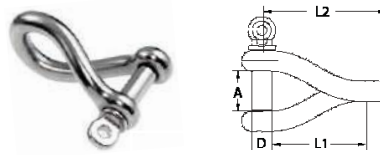

Code	Size	D	A	L1	L2	BL
S380-06	6	6	11.8	33	43	1600
S380-08	8	8	15.5	40.5	51.5	2800
S380-10	10	10	20.8	47	61.5	4600



Long Twisted Shackle AISI 316

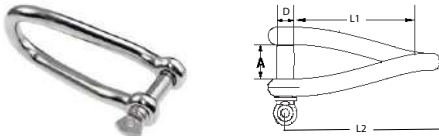

Code	Size	D	A	L1	L2	BL
S381-06	6	6	12	44	20	1600
S381-08	8	6	17.8	62.8	75	2800
S381-10	10	10	22.3	79	94.5	3800



Please specify ProRig (Cast) or Econ (Forged) range when ordering.

Lightweight Strip Shackle AISI 304



Code	Size	D	A	L1	L2
S162-04	4	4	10	17	25



Slot Head Dee Shackle AISI 316



Code	Size	D	A	L1	L2	BL
S360C-04	4	4	8	14	24	552
S360C-06	6	6	12	21	35	1700
S360C-08	8	8	15	28	47	2500
S360C-10	10	10	20	35	60	4100

Please specify ProRig (Cast) or Econ (Forged) range when ordering.



Cast



Forged

Semi Round Dee Shackle AISI 304



Code	Size	D	A	L1	L2	BL
S361I-05	5	5	12	19	30	950
S361I-06	6	6	12	22	36	1500



SWIVELS

Eye/Eye Swivel AISI 316

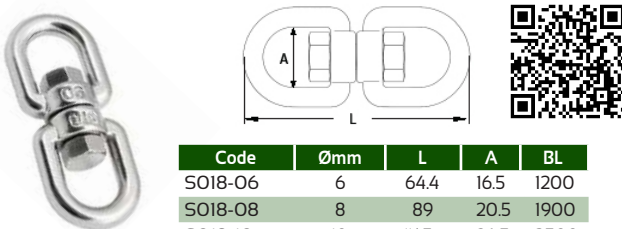

Code	Ømm	L	A	BL
S018-06	6	64.4	16.5	1200
S018-08	8	89	20.5	1900
S018-10	10	116.5	24.5	3500



Jaw/Jaw Swivel AISI 316

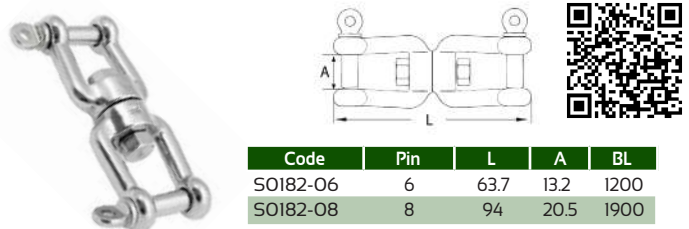

Code	Pin	L	A	BL
S0182-06	6	63.7	13.2	1200
S0182-08	8	94	20.5	1900
S0182-10	10	113	21	3500



BOTTLESCREW JAW/SWAGE

Bottlescrew Jaw/Swage AISI 316

Code	Thread	For Wire	L-Min	L-Max	Pin	D	A	H	BL
S312T-0805	M8	5.0mm	210	300	8	10.2	11	11	1400
S312T-1006	M10	6.0mm	255	350	10	12.5	12	15	2200
S312T-1206	M12	6.0mm	295	425	12	12.5	15	21	4000
S312T-1208	M12	8.0mm	310	445	12	16.1	14	21	4500
S312T-1610	M16	10mm	390	555	16	17.85	17.3	25.25	8200
S312T-2012	M20	12mm	465	645	20	21	20	28	12500
S312T-2416	M24	16mm	625	820	24	28	30	40	18500

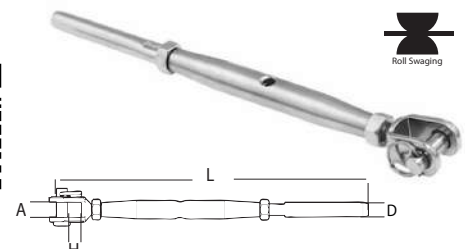

EYE BOLTS

Eye Nut Bolts AISI 316

(With nut & 1 washer)

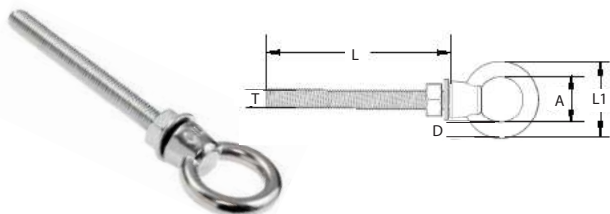

Code	Size	T	L	A	D	LI	BL
S307-10100	10x100	M10	100	25	8	40	2600
S307-10120	10x120	M10	120	25	8	40	2600
S307-10160	10x160	M10	160	25	8	40	2600
S307-10200	10x200	M10	200	25	8	40	2600
S307-12100	12x100	M12	100	30	10	50	3500
S307-12150	12x150	M12	150	30	10	50	3500
S307-12165	12x165	M12	165	30	10	50	3500
S307-12200	12x200	M12	200	30	10	50	3500
S307-16060	16x60	M16	60	35	14	60	8000
S307-16100	16x100	M16	100	35	14	60	8000
S307-16125	16x125	M16	125	35	14	60	8000
S307-16150	16x150	M16	150	35	14	60	8000



Please specify ProRig or Econ range when ordering.

Eye Bolts AISI 316/304 (With nut & 2 washers)

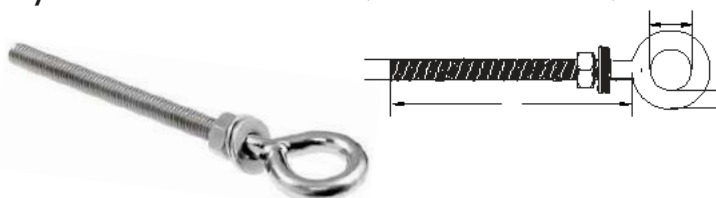

Code	Size	Grade	T	L	A	D	BL
S3191-06040	6x40	316	M6	40	13	6	1000
S3191-06055	6x55	316	M6	55	13	6	1000
S3191-06060	6x60	316	M6	60	13	6	1000
S3191-06080	6x80	316	M6	80	13	6	1800
S3191-08035304	8x35	304	M8	35	17	8	1800
S3191-08060	8x60	316	M8	60	17	8	1800
S3191-08080	8x80	316	M8	80	17	8	1800
S3191-08100	8x100	316	M8	100	17	8	1800
S3191-08120	8x120	316	M8	120	17	8	1800
S3191-10060	10x60	316	M10	60	21	10	2400
S3191-10080	10x80	316	M10	80	21	10	2400
S3191-10120	10x120	316	M10	120	21	10	2400
S3191-10150	10x150	316	M10	150	21	10	2400
S3191-10160	10x160	316	M10	160	21	10	2400
S3191-12120	12x120	316	M12	120	25	12	3500
S3191-12185	12x185	316	M12	185	25	12	3500



Scan QR code to check pricing.
Login to your account to view your trade price.

EYE NUTS

Eye Nuts AISI 316/304

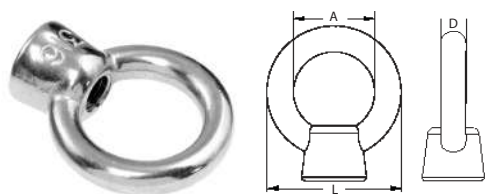

316



304

Code	Thread	Grade	A	D	L	BL
S3061-06	M6	316	16	5	26	1100
S3061-06304	M6	304	16	5	26	840
S3061-08	M8	316	20	6	32	1300
S3061-08304	M8	304	20	6	32	1450
S3061-10	M10	316	25	8	40	2600
S3061-10304	M10	304	25	8	40	2300
S3061-12	M12	316	30	10	49	3500
S3061-12304	M12	304	30	10	49	3300
S3061-16	M16	316	35	12	59	5799
S3061-16304	M16	304	35	12	59	5900
S3061-20	M20	316	39	16	70	10500
S3061-20304	M20	304	39	16	70	9200

Eye Bolts with Collar AISI 316/304



Code	T	Grade	L	A	D	LI	BL
S580-06	M6	316	10	15	6	37	1300
S580-06304	M6	304	11.5	16	5	28	840
S580-08	M8	316	14	20	8	36	2000
S580-08304	M8	304	13	20	7	33.5	1500
S580-10	M10	316	17	25	8	36	2000
S580-10304	M10	304	17	25	9.2	41.5	2300
S580-12	M12	316	20.5	30	12	53.5	4900
S580-12304	M12	304	20	30	11.2	51	3300
S580-16	M16	316	27	34	14	63	7000
S580-20	M20	316	32	40	16	103	10000
S580-24	M24	316	38	50	20	128	12000

Please specify AISI 316 or AISI 304 when ordering.

Eye Nuts AISI 316 (582 Type)

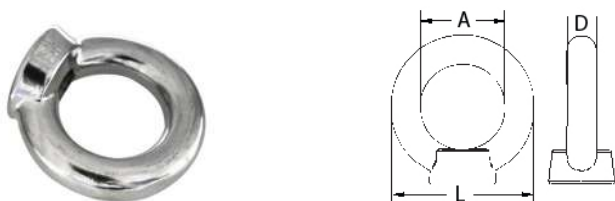

Code	Thread	A	D	L	BL
S582-08	M8	20	8	35	1400
S582-10	M10	25	10	45	1800
S582-12	M12	30	12	55	2200
S582-20	M20	40	16	72	10000
S582-24	M24	50	20	90	18000



SWAGE TERMINALS

Swage Studs AISI 316

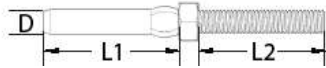

Miami Stainless can swage up to 28mm wire rope.
SIZES FROM 2.5mm TO 28mm AVAILABLE.
LHT - Left Hand Thread, RHT - Right Hand Thread



Code	For Wire	Thread	L	L1	L2	D
S780IL-050860	5mm	M8 LHT	128	57	51	9
S780IR-050860	5mm	M8 RHT	128	57	51	9
S780IR-0510115	5mm	M10 RHT	177	115	58	10
S780IR-0612143	6mm	M12 RHT	230	75	143	12.5
S780IR-061280	6mm	M12 RHT	162	79	63	12.5
S780IR-0641280	6mm	M12 RHT	163	80	83	12.7
S780IR-0816100	8mm	M16 RHT	214	102	80	16
S780IR-1020105	10mm	M20 RHT	225	105	100	18
S780IR-1220116	12mm	M20 RHT	278	116	144	21.5
S780IR-1424138	14mm	M24 RHT	330	140	170	25
S780IR-1624170	16mm	M24 RHT	387	170	192	28



Fork Terminal AISI 316

Code	For Wire	L	L1	D	D1
S7803-0508	5mm	85	11.5	9	8
S7803-0509	5mm	88	12	9	8
S7803-0612	6mm	108	15	13	12
S7803-0814	8mm	148	15	16	14
S7803-1016	10mm	154	17	18	16
S7803-1220	12mm	176	20	22	20
S7803-1424	14mm	257	30	25	24
S7803-1624	16mm	281	30	28.5	24



WIRE ROPE FITTINGS

Scan QR code to check pricing.
Login to your account to view your trade price.

Thimbles AISI 316

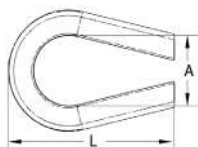

Code	For Wire	Grade	A	L
S234-0255	2.5mm	316	8	23
S234-03	3.2mm	316	12	29
S234-04S	4.0mm	316	11	22
S234-04	4.0mm	316	13	34
S234-05	5.0mm	316	15	37
S234-06S	6.0mm	316	15	39
S234-06	6.0mm	316	17	40
S234-08	8.0mm	316	22	48
S234-10	10.0mm	316	25	59
S234-12	12.0mm	316	29	66
S234-14	14.0mm	316	34	74
S234-16	16.0mm	316	37.5	83



All sizes available from stock to suit wire or rope up to 45mm.
"S" type thimbles are a smaller size and are well suited to wire balustrade.

Croc Swage Sleeves - Ferrules (Nickel Plated Copper)

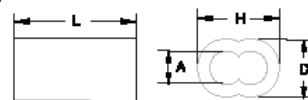

- Heat treated for softer finish and stronger hold.
- Improved plating process to minimise flaking.
- Exceeds breaking strain of wire with no slippage.

Code	Suits Wire	Brand	D	L	A	H
CS-112NP	1.2mm	Croc	3	9	1	5
CS-116NP	1.6mm	Croc	4	10	1.5	6
CS-120NP	2.0mm	Croc	5.5	11	2	8
CS-125NP	2.5mm	Croc	6	10	2.5	7
CS-130NP	3.2mm	Croc	7	13	3	10.5
CS-140NP	4mm	Croc	9.5	16	4	14.5
CS-150NP	5mm	Croc	11	22	5.5	17
CS-160NP	6mm	Croc	14	28	7	20
CS-164	6.4mm	Clamp	13	20	7	20
CS-180NP	8mm	Croc	17.5	29	9	27

A safety factor should be applied to these readings depending on the situation of use.

Wire Rope Grips 'Q' Type AISI 316



Code	For Wire	Thread
S260Q-03	3.2mm	4
S260Q-04	4mm	5



Wire Rope Grips AISI 316



Code	For Wire	Thread
S260-02	2mm	M2
S260-03	3.2mm	M3
S260-04	4mm	M4
S260-05	5mm	M5
S260-06	6mm	M6
S260-08	8mm	M8
S260-10	10mm	M10
S260-12	12mm	M12
S260-14	14mm	M12
S260-16	16mm	M13
S260-19	19mm	M14
S260-22	22mm	M16



ECON

Scan QR code to check pricing.

Login to your account to view your trade price.

ECON WIRE ROPE

Econ Hardware and Wire Rope is the new quality standard for low cost stainless steel fixtures and fittings. At competitive prices, the new, larger range of Econ stainless steel hardware gives your budget more flexibility while you still enjoy the trusted quality and unrivalled service you expect from Miami Stainless.

ECON Wire Rope AISI 316

Code	Size	Construction	BS	\$/Metre
WEO3.077	3.0	7x7	548	0.70
WEO3.2119	3.2	1x19	1052	0.89
WEO3.2719	3.2	7x19	663	0.87
WEO3.277	3.2	7x7	626	0.75
WEO4.77	4.0	7x7	918	1.21
WEO4.119	4.0	1x19	1449	1.34
WEO4.719	4.0	7x19	871	1.27
WEO5.719	5.0	7x19	1359	1.66
WEO6.119	6.0	1x19	3120	2.75
WEO6.719	6.0	7x19	1917	2.43
WEO8.119	8.0	1x19	5506	5.21
WEI2.119	12.0	1x19	12169	11.42

Metre, 50M, 100M
& 305M Rolls

1x19



7x7



7x19

ECON Wire Rope AISI 304

Code	Size	Construction	BS
WEO3.2719-304	3.2	7x19	663
WEO4.719-304	4.0	7x19	871
WEO4.77-304	4.0	7x7	918
WEO5.719-304	5.0	7x19	1359
WEO6.719-304	6.0	7x19	1917
WEO8.119-304	8.0	1x19	5518
WEI0.119-304	10.0	1x19	8586

Metre & 305M Rolls



Leech Cord

Code	Size	Colour	Roll Length	BL
C-LE-04100BK	4mm	Black	100m	400kg
C-LE-04200BK	4mm	Black	200m	400kg
C-LE-04400BK	4mm	Black	400m	400kg
C-LE-04100WH	4mm	White	100m	400kg
C-LE-04200WH	4mm	White	200m	400kg
C-LE-04400WH	4mm	White	400m	400kg
C-LE-05200BK	5mm	Black	200m	655kg
C-LE-05200WH	5mm	White	200m	655kg



Black



White

VB Cord

Code	Size	Colour	Roll Length	BL
C-VB-04100BK	4mm	Black	100m	400kg
C-VB-04200BK	4mm	Black	200m	400kg
C-VB-04400BK	4mm	Black	400m	400kg
C-VB-04100WH	4mm	White	100m	400kg
C-VB-04200WH	4mm	White	200m	400kg
C-VB-04400WH	4mm	White	400m	400kg
C-VB-05200BK	5mm	Black	200m	600kg
C-VB-05200WH	5mm	White	200m	600kg



Black



White

BS = Breaking Strain (kg) All sizes in mm

Scan QR code to check pricing.
Login to your account to view your trade price.

PRORIG WIRE ROPE

ProRig stainless steel wire rope is produced by a single Korean manufacturer with stringent quality control procedures and more than 30 years experience in manufacturing wire rope products. Because ProRig wire rope comes from a single manufacturer you can be assured you are getting a consistently high quality product and none of the problems associated with budget wires. Miami Stainless has confidently supplied this wire rope in Australia now for over 20 years.



Wire Rope AISI 316 50M & 100M Rolls

Code	Size	Construction	BS
W03.277	3.2	7x7	685
W03.2119	3.2	1x19	857

Wire Rope AISI 316

Code	Size	Construction	BS
W01.277	1.2	7x7	87
W01.677	1.6	7x7	165
W01.6119	1.6	1x19	215
W02.577	2.5	7x7	400
W02.5719	2.5	7x19	367
W02.5119	2.5	1x19	525
W0377	3.0	7x7	585
W03.277	3.2	7x7	685
W03.2719	3.2	7x19	695
W03.2119	3.2	1x19	857
W0477	4.0	7x7	1030
W04719	4.0	7x19	960
W04119	4.0	1x19	1340
W0577	5.0	7x7	1620
W05719	5.0	7x19	1490
W05119	5.0	1x19	2019
W0677	6.0	7x7	2330
W06719	6.0	7x19	2150
W06119	6.0	1x19	2910
W0877	8.0	7x7	3950
W08719	8.0	7x19	3820
W08119	8.0	1x19	5044
W1077	10.0	7x7	5517



316

- ProRig Wire is the highest quality Korean made wire rope.
- 7x7 strand is semi-flexible wire that can be hand swaged.
- 7x19 strand is very flexible wire that can be hand swaged.
- 1x19 is the least flexible wire and will fatigue if bent around tight corners.
- 1x19 should be swaged with a hydraulic press.



Wire Rope AISI 304 Metre & 305M Rolls

Code	Size	Construction	BS
W03.2719-304	3.2	7x19	715
W03.277-304	3.2	7x7	750
W04719-304	4.0	7x19	1089
W0477-304	4.0	7x7	1139
W05719-304	5.0	7x19	1698
W0577-304	5.0	7x7	1788



304

- ✓ Reliable Breaking Strains
- ✓ Superior Rust Resistance
- ✓ Superior Surface Finish

BS = Breaking Strain (kg) All sizes in mm

NOTE: MORE SIZES AVAILABLE, CONTACT OUR TEAM FOR MORE INFO.

PVC COATED WIRE

Code	Size	Construction	BS
WPO2.077-CL	2.0	7x7	260
WPO2.577-CL	2.5	7x7	400
WPO2.577-BK	2.5	7x7	400
WPO2.577-WH	2.5	7x7	400
WPO2.577-BU	2.5	7x7	400
WPO2.577-RD	2.5	7x7	400
WPO3.277-CL	3.2	7x7	665
WPO3.277-WH	3.2	7x7	665
WPO3.277-BU	3.2	7x7	665
WPO3.277-RD	3.2	7x7	665
WPO3.2719-BK	3.2	7x19	611

Code	Size	Construction	BS
WPO477-CL	4.0	7x7	1030
WPO4719-BK	4.0	7x19	960
WPO4719-WH	4.0	7x19	960
WPO4719-BU	4.0	7x19	960
WPO4719-RD	4.0	7x19	960
WPO577-CL	5.0	7x7	1620
WPO5719-BK	5.0	7x19	1490
WPO5719-WH	5.0	7x19	1490
WPO5719-RD	5.0	7x19	1490
WPO6719-BK	6.0	7x19	2150



Red - RD



Clear - CL



White - WH



Black - BK



Blue - BU



Scan QR code to check pricing.
Login to your account to view your trade price.

ANCHORS

Sleeve Anchor Hex Head AISI 316

Suitable for use with eye nuts.



Code	Size	Drill Size	Thread	MT	Min Embed
ABHH-06040S	6.5 x 40	6.5mm	5mm	10mm	30mm
ABHH-08040S	8 x 40	8mm	6mm	5mm	35mm
ABHH-08065S	8 x 65	8mm	6mm	30mm	35mm
ABHH-08085S	8 x 85	8mm	6mm	50mm	35mm
ABHH-10050S	10 x 50	10mm	8mm	10mm	40mm
ABHH-10075S	10 x 75	10mm	8mm	35mm	40mm
ABHH-12060S	12 x 60	12mm	10mm	10mm	50mm
ABHH-12075S	12 x 75	12mm	10mm	25mm	50mm
ABHH-12100S	12 x 100	12mm	10mm	50mm	50mm

Flush Head Sleeve Anchor AISI 316

Use with wall plates for a neat finish.



Code	Size	Drill Size	Thread	MT	Min Embed
ABFH-10040S	10 x 40	10mm	8mm	6mm	34mm
ABFH-10060S	10 x 60	10mm	8mm	20mm	40mm
ABFH-10080S	10 x 80	10mm	8mm	40mm	40mm
ABFH-10100S	10 x 100	10mm	8mm	60mm	40mm
ABFH-12075S	12 x 75	12mm	10mm	25mm	50mm

Through Bolt AISI 316

Suitable for use with eye nuts.



Code	Size	Drill Size	Thread	MT	Min Embed
ABTB-12080S	12 x 80	12mm	12mm	5mm	60mm
ABTB-12100S	12 x 100	12mm	12mm	25mm	60mm
ABTB-16105S	16 x 105	16mm	16mm	5mm	80mm
ABTB-20125S	20 x 125	20mm	20mm	5mm	100mm

Screw Bolt (Galvanised)

For use in solid cores such as concrete or soft cores such as hollow brick.

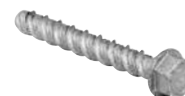

Code	Size	Drill Size	Thread	MT
SB-08060G	8 x 60	8mm	HEX	20mm
SB-10060G	10 x 60	10mm	HEX	20mm
SB-10100G	10 x 100	10mm	HEX	60mm
SB-12075G	12 x 75	12mm	HEX	25mm
SB-12100G	12 x 100	12mm	HEX	50mm



THREADED ROD

Threaded Rod Stud Assemblies AISI 304

Threaded studs come with 2 nuts and 2 washers.



Code	Size	Description
SROD-16A	M16 x 247mm	Suits 16mm Rafter Bracket
SROD-20A	M20 x 295mm	Suits 20mm Rafter Bracket



Threaded Rod AISI 304 (1 metre lengths)



Code	Size
SR304-06	M6
SR304-08	M8
SR304-10	M10
SR304-12	M12
SR304-16	M16
SR304-20	M20

Threaded Rod AISI 316 (1 metre lengths)

Code	Size
SR316-06	M6
SR316-08	M8
SR316-10	M10
SR316-12	M12
SR316-16	M16
SR316-20	M20



All sizes in mm

WALL FIXING

Scan QR code to check pricing.
Login to your account to view your trade price.

Diamond Pad Eyes AISI 316 / 304

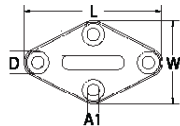

Code	Size	Grade	D	L	W	H	A	A1	BL
S3213-060	60	304	8	68	38	18	21	8	2200
S3213-090	90	304	8	89	57	23	22	8.6	4000
S3213-100	100	304	10	100	60	28	24.5	9	6000

Diamond Plates AISI 304

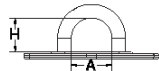
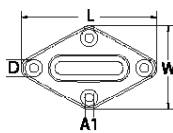

Code	Size	D	L	W	H	A	A1	BL
S3211-08	8	8	80	49	28	23	5	1600

Eye Plates AISI 304

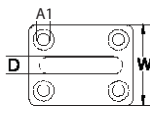
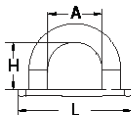

Code	Size	D	L	W	H	A	A1	BL
S321-06	6	6	40	34	16	20	4.8	1000
S321-08	8	8	50	39	23	23	5.5	1600
S321-10	10	10	60	48	30	25	5.3	2000

Oblong Plates AISI 316 / 304

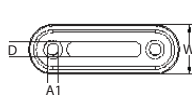
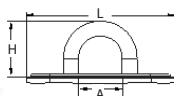

Code	Size	Grade	D	L	W	H	A	A1	BL
S3212-05	5	316	5	54	16	14	14	5	700
S3212-08	8	304	8	81	25	21	23	6.5	1600
S3212-09	9	304	9	100	32	24	29	8	1700

Round Eye Plates AISI 316

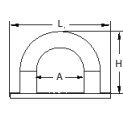
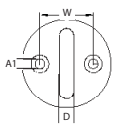

Code	Size	Grade	D	L	W	H	A	A1	BL
S3214-05	5	316	33	33	21	15	17	4	700
S3214-08	8	316	50	50	33	25	25	5	1600

Saddles (Eye Straps) AISI 316 / 304



PRORIG

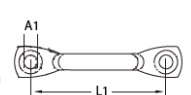
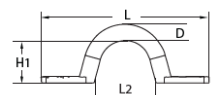

Code	D	L	H1	L1	L2	A1	Grade
S322-04	4	42	10	32	17	3.5	316
S322-05	5	52	13	38*	21	4	304
S322-05	5	52	13	38	21	4	316
S322-06	6	60	15	44	21	5	316
S322-08	8	64	17	50	25	6	304
S322-08	8	64	17	50	25	6	316
S322-10	10	68	16	52	18	5	304
S322-05S	5	42.5	11	28	6	8	316



ProRig saddles are 304 grade stainless, Econ & S322-05S are 316 grade stainless. S322-05S suits 5mm & 6mm bottlescrews. The smaller eye saddle has a neater appearance than standard saddles, as the eye is hidden behind the jaw of the bottlescrew or fork terminal. Measurements are taken from ProRig products, Econ products may vary slightly. Please specify ProRig or Econ range when ordering.

Breaching Staples AISI 316

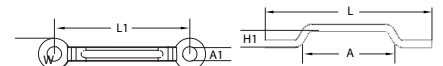

Code	L	H1	W	L1	A	A1
S323-25	54	8	11	43	25	5
S323-50	72	8	13.5	58	35	6.5

Rope Cleats AISI 316

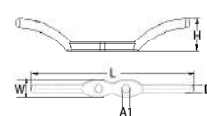

Code	L	W	H	D	A1
S4015-67	67	10.5	12	4	4
S4015-112	112	14	20	6.5	5.5
S4015-150	150	17	26	7.5	6.5
S508-06	150	43	20	10	7

Bulkhead Hook AISI 316

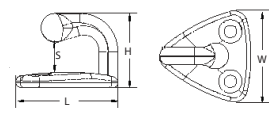

Code	Size	L	W	H	S
S5373-06	6	21	27	19	6

S = Minimum clearance between base plate and hook

Bulkhead Eye AISI 316

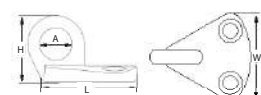

Code	Size	L	W	H	A
S5341-10	10	33	30	21	10

WALL FIXING

Round Hook Plates AISI 316

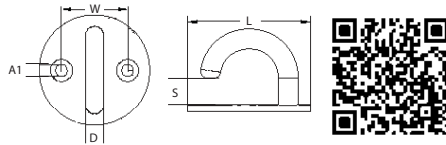

Code	Size	D	L	W	S	A1	BL
S3214H-06	6	6	40	40	12.5	4.5	220
S3214H-08	8	8	50	50	14.5	5.5	252

S = Minimum clearance between base plate and hook



Bulkhead Snap Hook AISI 316

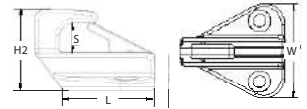

Code	Size	L	W	H2	S
S5359-05	5	37	34	25	5
S5359-10	10	40	34	33	10

S = Minimum clearance between base plate and hook



SCREW EYES

Eye Nut Screw Eyes AISI 316

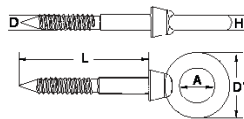

Code	Size	D	L	A	H	D1	Pull Out*
S3291-05060	5x60	5	60	11	5	20	550
S3291-06060	6x60	6	60	14	6	26	550
S3291-08080	8x80	8	80	18	8	33	820
S3291-10080	10x80	10	80	22	10	41	645
S3291-12100	12x100	12	100	27	12	50	1625
S3291-12140	12x140	12	140	27	12	50	1660
S3291-12160	12x160	12	160	27	12	50	1830



Welded Eye Screw Eye AISI 316

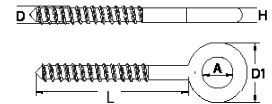

Code	Size	D	L	A	H	D1	Pull Out*
S7143-08080	8x80	8	80	16	8	32	1060
S7143-08130	8x130	8	130	16	8	32	1090
S7143-10060	10x60	10	60	20	10	40	1135
S7143-10080	10x80	10	80	20	10	40	1255
S7143-10100	10x100	10	100	20	10	40	1460
S7143-10130	10x130	10	130	20	10	40	1895
S7143-10150	10x150	10	150	20	10	40	2260



The 7143 screw eye features an extra-coarse thread.

Screw Eyes AISI 316

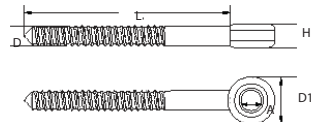

Code	Size	D	L	A	H	D1	Pull Out*
S3182-0555	5x55	5	55	5.2	6	12	780
S3182-0640	6x40	6	40	6.2	7**	14**	526
S3182-0640	6x40	6	40	6.2	7**	14**	547
S3182-0660	6x60	6	60	6.2	7**	14**	800
S3182-0660	6x60	6	60	6.2	7**	14**	709
S3182-0860	8x60	8	60	8.2	9	19	890
S3182-0880	8x80	8	80	8.5	8.7	18	-
S3182-10080	10x80	10	80	10.3	12	20	965
S3182-10100	10x100	10	100	10.3	12	20	1200
S3182-12100	12x100	12	100	12.3	14	25	1590
S3182-12120	12x120	12	120	12.3	14	25	1814

**6mm Econ Screw Eyes: H = 5, D1 = 12



*Pull out strengths are based on the maximum pull out loads achieved by using MGP 10

structural pine. They are intended as a guide only and a safety factor should be applied to these readings depending on the situation of use.

Much greater results can be achieved using hardwoods: for example Kwila will hold around 80-90% more tension.

MAME BLOCKS

Mame Block (Single Nylon Sheave) AISI 304

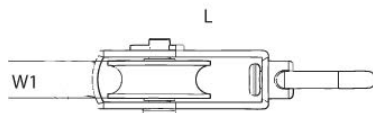

Code	Sheave	W1	L	BL	Rope
S314NL-32	32	10	93	1700	Up to 10mm
S314NL-50	50	13.5	124	2800	Up to 13mm



Mame Block (Double Nylon Sheave) AISI 304

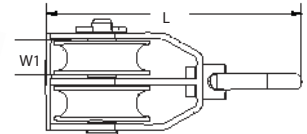

Code	Sheave	W1	L	BL	Rope
S315NL-32	32	10	94.5	1500	Up to 10mm
S315NL-50	50	14	127	2500	Up to 13mm



Mame Block with Becket (Single Nylon Sheave) AISI 304

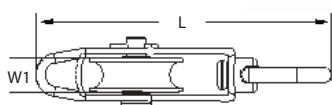

Code	Sheave	W1	L	BL	Rope
S314ENL-32	32	10	115.5	1700	Up to 10mm
S314ENL-50	50	13.5	147	2800	Up to 13mm



Mame Block with Becket (Double Nylon Sheave) AISI 304

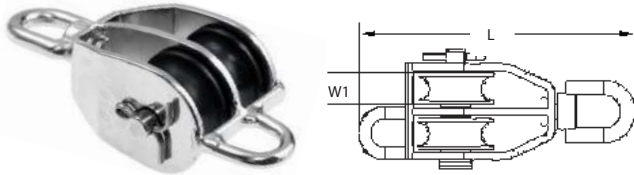

Code	Sheave	W1	L	BL	Rope
S315ENL-32	32	10	113	1500	Up to 10mm
S315ENL-50	50	14	148	2500	Up to 13mm



Mame Block with Becket (Single Cast Sheave) AISI 304

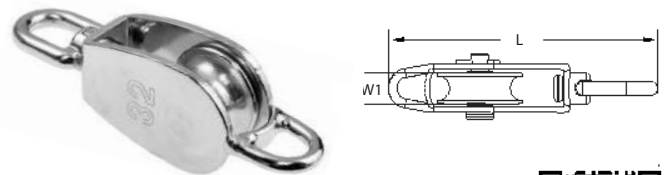

Code	Sheave	W1	L	BL	Rope
S314ES-32	32	12.5	115.5	1700	Up to 12mm
S314ES-50	50	14.5	147	2800	Up to 13mm



Mame Block (Single Cast Sheave) AISI 304

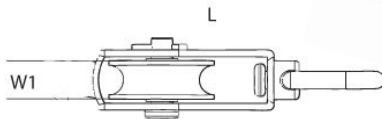

Code	Sheave	W1	L	BL	Rope
S314S-25	25	11.5	79	1500	Up to 11mm
S314S-32	32	12.5	91.5	1800	Up to 12mm
S314S-50	50	14.5	124	3500	Up to 13mm



PULLEY BLOCKS

Fixed Pulley Blocks AISI 316



S8259-1-25

S8259-2-25

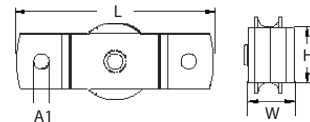

Code	Sheave	A1	H	W	L	Rope
S8259-1-25	25mm Single	8	18	16	65	Up to 5mm
S8259-2-25	25mm Double	8	30	26	65	Up to 5mm

Pulley Block (with Bracket & Fixed Pin) AISI 316



S8253-1-25

S8253-2-25

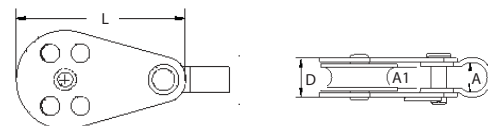

Code	Sheave	A	A1	D	L	Rope
S8253-1-25	25mm Single	10	8	12	45	Up to 6.5mm
S8253-2-25	25mm Double	10	8	24	45	UP to 6.5mm



Pulley Block (with Removable Pin) AISI 304

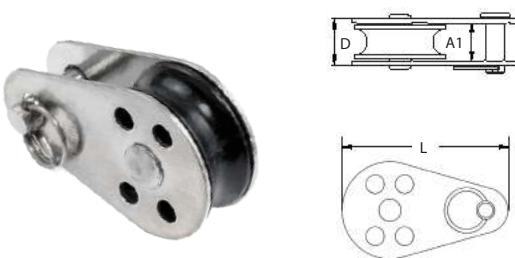

Code	Sheave	D	A1	L	Rope
S8252-25	25	8	5	45	Up to 6.5mm



Scan QR code to check pricing.

Login to your account to view your trade price.



FLUSH RING PULLS

Flush Ring Pull (Heavy Duty Cast) AISI 316

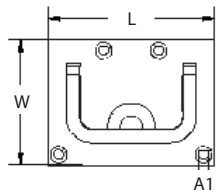

Code	W	L	A1
S5400H-76	57	76	4



Countersink into surface to create a flush ring.

Flush Ring Pull (Pressed) AISI 316

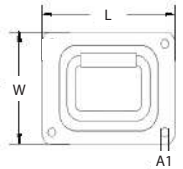

Code	W	L	A1
S5400P-76	57	76	4

Countersink into surface to create a flush ring.

Flush Ring Pull (Round) AISI 316

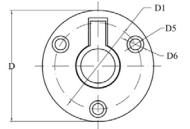

Code	D	D1	D5	D6
S5400R-50	50	41	11	4.3

Countersink into surface to create a flush ring.



CAFE BLIND ANCHOR

Scan QR code to check pricing.
Login to your account to view your trade price.

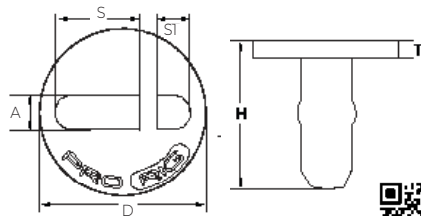

Cafe Blind Anchor AISI 316

Code	D	H	T	A	S	SI
S3215-50	49	45	5	10	25	10

- ✓ Extremely quick and easy to install in concrete.
- ✓ Simply core drill a 50mm hole, fill with grout and insert the plug.
- ✓ No need to cut and chisel any awkward shapes in the concrete surface.
- ✓ Attractive and stylish mirror polish finish.
- ✓ Sits flush with surface once installed to eliminate trip hazards when not in use.
- ✓ A quality 316 marine grade ProRig® product.
- ✓ Tested to 900kg's without deformation.

PRO RIG

ORIGINAL DESIGN

Registered Design No. 12142/2010

INSTALLATION TOOLS

Diamond Core Drill



Diamond core power drills are perfect for installing ProRig Original Design café blind anchor housings with a 50mm diamond core drill bit.

Code	Description	Max Hole Ø
PT-3505	1500W - 2100/950rpm	80mm

Diamond Core Drill Bit



Diamond core drill bits are specifically designed to core drill 50mm holes to suit ProRig Original Design café blind anchor housings.

Code	Description	Core Drill Length
DCD-50	50mm bit to suit PT-3505	450mm

HOOKS

Spring Hooks AISI 316

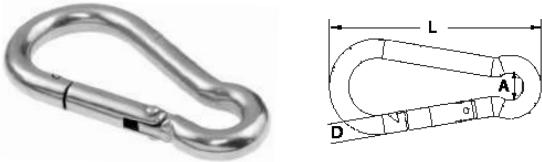

Code	Size	D	L	A	BL
S2450-05	5	5	55	8	220
S2450-06	6	6	68	8.5	272
S2450-08	8	8	80	11	508
S2450-10	10	10	100	15	728
S2450-11	11	11	120	17	816



S Hook AISI 304



Code	Size	D	L	A	S	BL
S874-03	3	3	37	9	16	25



Spring Hooks (with Eye) AISI 316

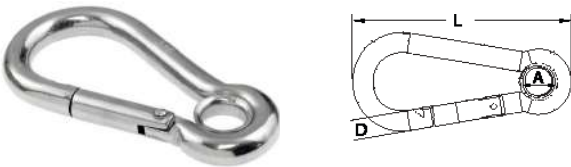

Code	Size	D	L	A	BL
S2450WE-05	5	5	50	7	220
S2450WE-06	6	6	60	7	272
S2450WE-08	8	8	80	10	508
S2450WE-10	10	10	100	13	728



S Hook AISI 304



Code	Size	D	L	A	S	BL
S875-06	6	6	60	10	12	200
S875-08	8	8	75	16	18	400
S875-09	9	9	80	17	18	650



S Hook AISI 316

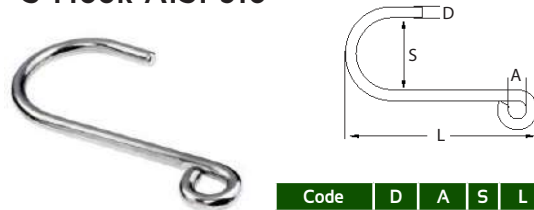

Code	D	A	S	L
S876-640	6	10	40	105



Spring Hooks (with Eye & Screw Nut) AISI 316



Code	Size	D	L	A	BL
S2450WEN-06	6	6	60	7	456
S2450WEN-08	8	8	80	10	728
S2450WEN-10	10	10	100	13	1092



Swivel Eye Bolt Snap AISI 316

Suits café blind anchor housing. SQ = Square Swivel Eye

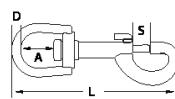

Code	D	L	A	S	BL
S225-080SQ	5	80	14	6.5	180
S225-090	5	90	36	8.1	650
S225-120	6.5	120	25	13	550



Cast Snap Hooks AISI 316



Code	Size	L	W	S	BL
S2470-050	50	50	23	10	220
S2470-070	70	69	30	12	500
S2470-100	100	96	46	20	900



Swivel Eye Snap AISI 316



Code	D	L	A	S	BL
S251-070	3.5	68	13	4	152
S251-085	4	87	20	7	172
S251-100	6	100	21	21	172



'J' Hook AISI 316

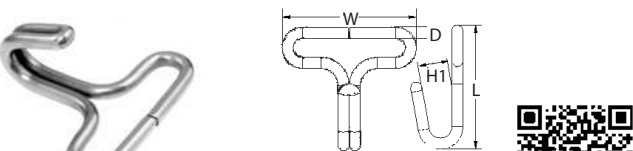

Code	L	D	W	H	HI
S326-25	32	3	36	16	8.1



Double Ended Bolt Snap AISI 316



Code	L	A	S	BL
S226-105	105	10	8.1	352



LINKS

C-Links AISI 316

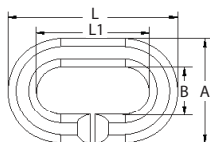

Code	Size	A	B	L	LI	BL
SIOC-10	10	35	15	60	40	548
SIOC-11	11	39	16	66	45	948
SIOC-13	13	48	19	78	52	1300
SIOC-16	16	60	22	98	62	1700



Quick Links AISI 316

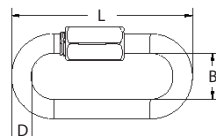

Code	Size	B	D	L	Thread	BL
S7350-04	4	12	4	33	M6	1400
S7350-06	6	14	6	46	M9	3250
S7350-08	8	18	8	75	M11	5500
S7350-10	10	20	10	72.5	M13	9000
S7350-12	12	24	12	104.5	M15	12500
S7350-16	16	31	16	140	M19	22500



CHAIN

Scan QR code to check pricing.
Login to your account to view your trade price.

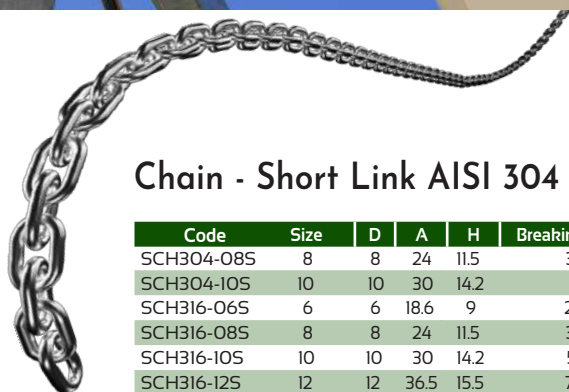

Chain - Short Link AISI 304 / AISI 316

Code	Size	D	A	H	Breaking Strain (kg)
SCH304-08S	8	8	24	11.5	3260
SCH304-10S	10	10	30	14.2	5100
SCH316-06S	6	6	18.6	9	2400
SCH316-08S	8	8	24	11.5	3260
SCH316-10S	10	10	30	14.2	5100
SCH316-12S	12	12	36.5	15.5	7500

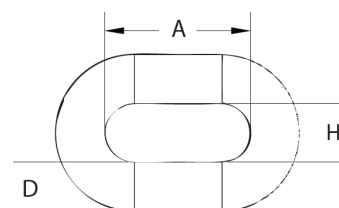

Proof tested to Australian standard.

Chain - Medium Link AISI 304

Code	Size	D	A	H	Proof Test Load (kg)	Breaking Strain (kg)
SCH304-03M	3	3	15.7	7.1	120	900
SCH304-04M	4	4	18.6	8	220	1100
SCH304-06M	6	6	26.1	11.5	640	2945
SCH304-08M	8	8	32.2	13.5	1060	5130
SCH304-10M	10	10	39.1	16.2	1660	6685
SCH304-12M	12	12	46	20	2700	7240



Proof tested to Australian standard.

Chain - Medium Link AISI 316

Code	Size	D	A	H	Proof Test Load (kg)	Breaking Strain (kg)
SCH316-02M	2	2	14.4	5	91	183
SCH316-03M	3	3	15.7	7.1	120	700
SCH316-04M	4	4	18.6	8	220	885
SCH316-06M	6	6	26.1	11.5	640	3355
SCH316-08M	8	8	32.2	13.5	1060	5000
SCH316-10M	10	10	39.1	16.2	1660	6555
SCH316-12M	12	12	46	20	2700	7065
SCH316-16M	16	16	59.6	24.5	4620	13,865



Proof tested to Australian standard.

Please specify AISI 316 or AISI 304 when ordering. All sizes in mm

FASTENERS

Brass Standard Hex Nuts



Code	Thread
BN-12	M12
BN-16	M16
BN-20	M20



Nylon Lock Nuts AISI 316



Code	Thread
SNL-05	M5
SNL-06	M6
SNL-08	M8
SNL-10	M10
SNL-12	M12
SNL-16	M16



Dome Nuts AISI 316



Code	Thread
SDN-06	M6
SDN-08	M8
SDN-10	M10
SDN-12	M12
SDN-16	M16
SDN-20	M20



Standard Hex Nuts AISI 316



Code	Thread
SN-03	M3
SN-04	M4
SN-05	M5
SN-06	M6
SN-08	M8
SN-10	M10
SN-12	M12
SN-16	M16
SN-20	M20



Flat Round Washers AISI 316



Code	Thread
SW-05	M5
SW-06	M6
SW-08	M8
SW-10	M10
SW-12	M12
SW-16	M16
SW-20	M20
SW-24	M24



COACH SCREWS

Coach Screw Stainless Steel AISI 316 (To suit Mungo Plugs)



Code	Size	Head
CSHH-06050S	6 x 50	HEX
CSHH-08065S	8 x 65	HEX
CSHH-10075S	10 x 75	HEX
CSHH-12075S	12 x 75	HEX



Coach Screw Galvanised (To suit Mungo Plugs)



Code	Size	Head
CSHH-06050G	6 x 50	HEX
CSHH-08065G	8 x 65	HEX
CSHH-10075G	10 x 75	HEX
CSHH-12075G	12 x 75	HEX



NYLON ANCHORS

Mungo Nylon Plugs



For use in solid cores such as concrete, natural stone and brick.

Code	Size	Drill Size	Coach Screw	Metric Thread
MP-08	8 x 40	8mm	4.5-6mm	5mm
MP-10	10 x 50	10mm	6-8mm	6mm
MP-12	12 x 60	12mm	8-10mm	8mm
MP-14	14 x 70	14mm	10-12mm	10mm
MP-16	16 x 80	16mm	12-14mm	12mm



Mungo Multi Plugs



For use in soft and hollow cores such as plaster, aerated concrete and hollow brick.

Code	Size	Drill Size	Coach Screw	Metric Thread
MMP-08	8 x 50	8mm	4.5-6mm	6mm
MMP-10	10 x 60	10mm	6-8mm	8mm
MMP-12	12 x 70	12mm	8-10mm	10mm
MMP-14	14 x 80	14mm	10-12mm	12mm



FASCIA BRACKETS

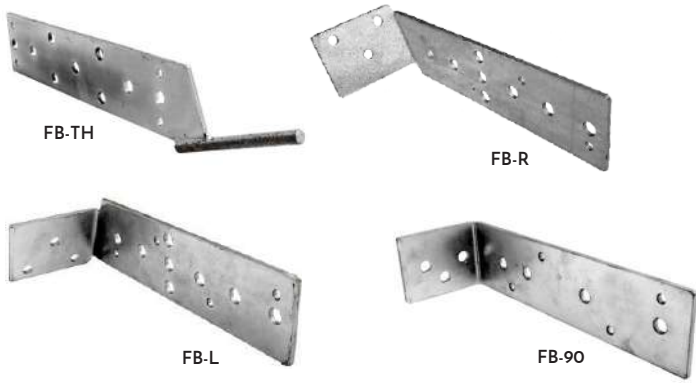

Code	Description	Finish
FB-L	Fascia Bracket for 20 deg Rafter Angle – Left	Galvanised
FB-R	Fascia Bracket for 20 deg Rafter Angle – Right	Galvanised
FB-90	Fascia Bracket for Flat Roofs	Galvanised
FB-TH	Fascia Bracket with 12mm Thread	Galvanised
FB-2W	Fascia Bracket 2 Way	Galvanised



Scan QR code to check pricing.
Login to your account to view your trade price.

RAFTER BRACKETS



New RB-30A

- Over 5 times stronger than other rafter brackets
- Made with high strength steel
- Only 2.5mm of deflection at the tile height when loaded to 1200kg
- Lower cost than other Rafter Bracket Assemblies
- Special Design Large Oversized Washers Included to spread the load over a larger area
- 2 through holes allow for fitting of Eye Bolts in 4 directions
- Shade sail can be connected at any angle



Code	Description	Finish
RB-GW-L	Rafter Bracket for Guy Wires – 16mm Thread	Zinc
RB-GW-R	Rafter Bracket for Guy Wires – 16mm Thread	Zinc
RB-16	Rafter Bracket to suit 16mm Threaded Rod	Galvanised
RB-16BP	16mm Rafter Bracket Backing Plate	Galvanised
RB-16A	16mm Rafter Bracket Full Assembly	Galvanised
RB-20	Rafter Bracket to suit 20mm Threaded Rod	Galvanised
RB-20BP	20mm Rafter Bracket Backing Plate	Galvanised
RB-20A	20mm Rafter Bracket Full Assembly	Galvanised
RB-30A	20mm Rafter Bracket Backing Plate	Galvanised



NEW PRODUCT

RB-30A
MBL - 2000kg
Registered Design®



RB-GW



RB-16



RB-16BP



MBL - 300kg
RB-16A



RB-20



RB-20BP



MBL - 300kg
RB-20A

MBL - Max. Break Load

RAFTER BRACKET ACCESSORIES

DEKS Dektite Flashing (For Tin Roofs)

- ✓ Low profile base with watershed sleeve
- ✓ Larger square base will cover a larger opening
- ✓ Unique cone design
- ✓ Clear marking in metrics & imperial measurements



* Always use the neutral cure low modulus silicone for sealing
 * In corrosive and coastal environments fix using blind aluminium rivets

Code	Tube Size	Base	Pitch	Suits
DFE-O35	0-35mm	99 x 99	0-60	16 & 20 RB-ASSY
DFE-O55	5-55mm	137 x 137	0-45	16 & 20 RB-ASSY

DEKS Square Dektite Flashing (For Tin Roofs)



- ✓ Suitable for both standard and retrofit applications
- ✓ Larger square base will cover a large opening
- ✓ Unique cone design
- ✓ Clear markings in metric and imperial measurements



* Always use the neutral cure low modulus silicone for sealing
 * Use 10x16 Hex head self-drilling screws
 * In corrosive and coastal environments fix using blind aluminium rivets
 * Clips included

Code	Tube Size	Base	Pitch	Colour	Suits
DFS-20125	20-125mm	216 x 216	0-40	Black	20-125mm Square Posts

DEKS Dektite Flashing (For Tile Roofs)



- ✓ Environmentally friendly
- ✓ Won't stain or corrode spouting and gutters
- ✓ Easy installation
- ✓ Paint to match any roof



* Always use the neutral cure low modulus silicone for sealing

Code	Tube Size	Base	Pitch	Colour	Suits
TFA-1270B	12-70mm	600 x 450	0-40	Black	16 & 20 RB-ASSY
TFA-50170B	50-170mm	600 x 500	0-40	Black	16 & 20 RB-ASSY
TFA-50170B/5	50-170mm	600 x 500	0-40	Black	16 & 20 RB-ASSY

CORNER BRACKETS

Internal Corner Brackets AISI 316 / 304

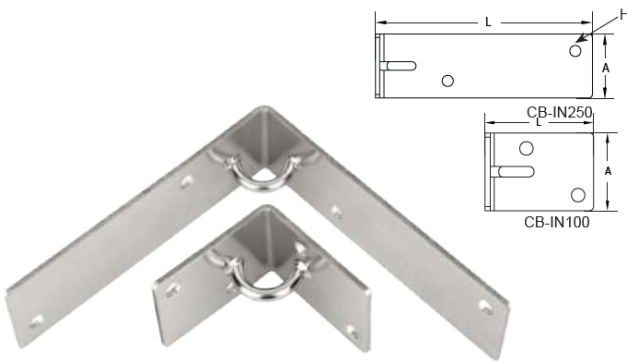

Galvanised

Code	Size	L	A	H	Corner	Material	Plating
CB-IN250	250	250	75	12.5	Internal	Steel	Galv



AISI 304

Code	Size	L	A	H	Corner	Material
CB-IN100S304	100	100	75	12.5	Internal	AISI 304
CB-IN250S304	250	250	75	12.5	Internal	AISI 304

AISI 316

Code	Size	L	A	H	Corner	Material
CB-IN100S	100	100	75	12.5	Internal	Stainless Steel AISI 316
CB-IN250S	250	250	75	12.5	Internal	Stainless Steel AISI 316

Galvanised

Code	Size	L	A	H	Corner	Material	Plating
CB-EX100I20	100	100	120	12.5	External	Steel	Galv
CB-EX250G	250	250	75	12.5	External	Steel	Galv

AISI 304

Code	Size	L	A	H	Corner	Material
CB-EX100S304	100	100	75	12.5	External	AISI 304
CB-EX250S304	250	250	75	12.5	External	AISI 304

AISI 316

Code	Size	L	A	H	Corner	Material
CB-EX100S	100	100	75	12.5	External	Stainless Steel AISI 316
CB-EX250S	250	250	75	12.5	External	Stainless Steel AISI 316

External Corner Brackets AISI 316 / 304

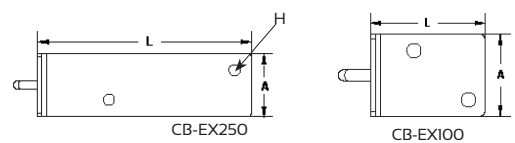

CORRUGATED RAFTER BRACKETS



Eye Nuts are sold separately

Scan QR code to check pricing.
Login to your account to view your trade price.

Roof Bracket Corrugated AISI 316

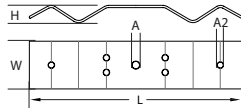

Code	L	W	A	A2	H	Material
RB-COR	285	64	10	8	22	Stainless Steel AISI 316



Roof Bracket Trim Deck AISI 316

Code	L	W	A	A1	H	Material
RB-TRIM	270	75	10	8	50	Stainless Steel AISI 316

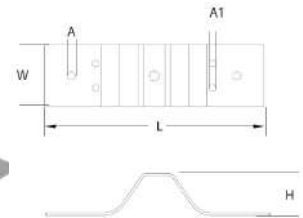

WALL PLATES

Stud Wall Bracket AISI 316

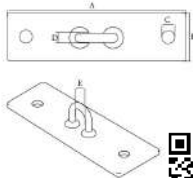

Code	A	B	C	D	E
STB-150S	150	40	11	8	14

ProRig® Diamond Shackle Wall Plate AISI 316



PRORIG
ORIGINAL DESIGN

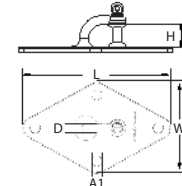

Code	Size	D	L	W	H	A1	BL
S3213-180PR	180 x 110	10	180	110	19	12.5	4500

Wall Plates - Diagonal Eye AISI 316 / 304

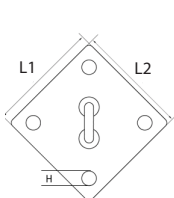

Galvanised

Code	Size	L1	L2	W	H	Material	Plating
WPD-150G	150 x 150	150	150	19	13	Steel	Galv

AISI 304

Code	Size	L1	L2	W	H	Material
WPD-100S304	100 x 100	100	100	13.5	13	Stainless Steel AISI 304
WPD-150S304	150 x 150	150	150	19	13	Stainless Steel AISI 304

AISI 316

Code	Size	L1	L2	W	H	Material
WPD-100S316	100 x 100	100	100	13.5	13	Stainless Steel AISI 316
WPD-150S316	150 x 150	150	150	19	13	Stainless Steel AISI 316

Diagonal wall plates reach more bricks than the standard square plates.

Wall Plates - Horizontal Eye AISI 316 / 304

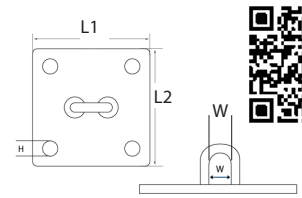

Galvanised

Code	Size	L1	L2	W	H	Material	Plating
WPH-150G	150 x 150	150	150	19	13	Steel	Galv

AISI 304

Code	Size	L1	L2	W	H	Material
WPH-100S304	100 x 100	100	100	13.5	13	Stainless Steel AISI 304
WPH-150S304	150 x 150	150	150	19	13	Stainless Steel AISI 304

AISI 316

Code	Size	L1	L2	W	H	Material
WPH-100S316	100 x 100	100	100	13.5	13	Stainless Steel AISI 316
WPH-150S316	150 x 150	150	150	19	13	Stainless Steel AISI 316

DRILL BITS

Sutton Cobalt Drill Bits



- ✓ Point Type & Angle: Split 135°
- ✓ Material: Cobalt
- ✓ Surface Finish: Colour Tempered Cobalt
- ✓ Suitable for: Metal / Stainless Steel

Code	Size	OAL	FL
DCB-030	3.0	61	33
DCB-035	3.5	70	39
DCB-040	4.0	75	43
DCB-045	4.5	80	47
DCB-050	5.0	86	52
DCB-055	5.5	93	57
DCB-060	6.0	93	57
DCB-065	6.5	101	63
DCB-070	7.0	109	69
DCB-075	7.5	109	69

Code	Size	OAL	FL
DCB-080	8.0mm	117	75
DCB-085	8.5mm	117	75
DCB-090	9.0mm	125	81
DCB-095	9.5mm	125	81
DCB-100	10.0mm	133	87
DCB-110	11.0mm	133	87
DCB-120	12.0mm	151	101
DCB-130	13.0mm	151	101
DCB-0873	11/32"	119	86



Code	Size	OAL	FL
DVP-030	3.0	61	33
DVP-035	3.5	70	39
DVP-040	4.0	75	43
DVP-045	4.5	80	47
DVP-050	5.0	86	52
DVP-055	5.5	93	57
DVP-060	6.0	93	57
DVP-065	6.5	101	63
DVP-070	7.0	109	69
DVP-075	7.5	109	69

Code	Size	OAL	FL
DVP-080	8.0mm	117	75
DVP-085	8.5mm	117	75
DVP-090	9.0mm	125	81
DVP-095	9.5mm	125	81
DVP-100	10.0mm	133	87
DVP-110	11.0mm	133	87
DVP-120	12.0mm	151	101
DVP-130	13.0mm	151	101
DVP-0873	11/32"	119	86



Sutton Viper Drill Bits

- ✓ Point Type & Angle: Viper 118°
- ✓ Material: HSS
- ✓ Surface Finish: Bright
- ✓ Suitable for: Metal / Wood / Plastic



Sutton Long Series Drill Bits



- ✓ Point Type & Angle: Viper 118°
- ✓ Material: HSS
- ✓ Surface Finish: Bright Blue
- ✓ Suitable for: Metal / Wood / Plastic

Code	Size	OAL	FL
DLS-040	4.0	146	86
DLS-050	5.0	152	92
DLS-075	7.5	162	102



STAYPUT™ FITTINGS

Stayput™ Dome Hook (Horizontal)



Code	Size	Fixing
DHOOK-HBL	60	Horizontal
DHOOK-HCE	60	Horizontal
DHOOK-HCL	60	Horizontal
DHOOK-HIV	60	Horizontal
DHOOK-HTE	60	Horizontal
DHOOK-HWH	60	Horizontal

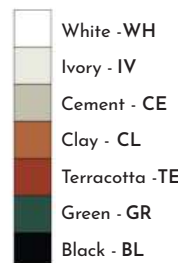

Stayput™ Dome Shock Cord Loop



Black

Code	Length (mm)
SCORD-70	70
SCORD-80	80
SCORD-90	90
SCORD-100	100
SCORD-110	110

Please specify black or white when ordering.



White

Stayput™ Dome Hook (Vertical)



Code	Size	Fixing
DHOOK-VBL	60	Vertical
DHOOK-VCE	60	Vertical
DHOOK-VCL	60	Vertical
DHOOK-VGR	60	Vertical
DHOOK-VIV	60	Vertical
DHOOK-VTE	60	Vertical
DHOOK-VWH	60	Vertical



Stayput™ Dome Hook (Saddle)



Code	Size	Fixing
DHOOK-SBL	60	Saddle
DHOOK-STE	60	Saddle
DHOOK-SWH	60	Saddle
DHOOK-SCE	60	Saddle



Stayput™ Spin Cut Tool

Code	Size
SCUT-06	6mm (1/4")



HAND SWAGING TOOLS



Croc DIY Hand Swager & Cutter

Code	Swages Wire	Brand	Length	Weight
HS-14CR	1.5, 2, 2.5, 3, & 3.2	Croc	360	930g

- ✓ Ideal for DIY use
- ✓ Swages 1.5mm to 3.2mm wire

This tool incorporates both swaging and cutting functions to provide quick and easy installation.



Croc HS-345CR Professional Hand Swaging Tool

Code	Swages Wire	Brand	Length	Weight
HS-345CR	3, 3.2, 4 & 5mm	Croc	780	3.8kg

- ✓ Ideal for shade sail installations
- ✓ Swages 3, 3.2, 4 & 5mm wire
- ✓ Recommended for high repetition use



Croc HS-6810CR Professional Hand Swaging Tool

Code	Swages Wire	Brand	Length	Weight
HS-6810CR	6, 8 & 10mm	Croc	1060	9.0kg

- ✓ Ideal for heavy duty installations
- ✓ Swages 6, 8 & 10mm wire
- ✓ Recommended for high repetition use



Croc® professional hand swaging tools are high quality and specifically designed for use with copper and nickel plated copper swaging sleeves.



Hand Swaging Video

WIRE ROPE CUTTERS



Code	Cuts ST/ST	Length	Weight	Brand
WC-04CR	4mm	195	305g	Croc
WC-04HIT	4mm	195	305g	HIT
WC-06HIT	6mm	335	706g	HIT
WC-06OPT	6mm	450	1.5kg	OPT
WC-08OPT	8mm	600	2.1kg	OPT
WC-08EC	8mm	450	1.8kg	Econ
WC-10HIT	10mm	520	1.1kg	HIT



LOCKWIRE

Stainless Steel Safetywire / Lockwire

Malin canisters are molded from high density polyethylene that won't degrade, keeping the wire free of grease and corrosive materials.

Code	Wire Size	Total Length
LW-020	0.020"	283 Metres
LW-025	0.025"	181 Metres
LW-032	0.032"	110 Metres
LW-041	0.041"	67 Metres
LW-051	0.051"	43.7 Metres





WIRE STRETCHING BED

Did you know that Miami Stainless has its own stretching bed in Burleigh Heads?

Our **20 metres, 80 tonnes stretching bed** is specially designed for the pre-installation stretching of wire and non-destructive testing of wire ropes, synthetic ropes, chains and shackles.

Need a long cable? We can handle any length.

We can apply load to 20 metres in one section however the unique design allows for stretching up to any length of cable as the cable can be tested in sections by passing it through the hydraulic cable grips and testing each subsequent section.

Need a large diameter cable tested?

Our machine will stretching up to 32mm diameter wire rope.

TERMS & CONDITIONS

COPYRIGHT MIAMI STAINLESS 2026. All images contained in this catalogue are the copyright of Miami Stainless and are not to be copied without permission.

Price Match Guarantee: The guarantee applies only to items that Miami Stainless has in stock. The items must be identical and Miami Stainless must be able to verify the competitors offer being made. The Price Match Guarantee request must be made at the time of purchase, and does not include quotes from online or sole traders. The item quantity for the Price Match Guarantee must be the same as that on the offer.

Specifications: Whilst every effort has been made to ensure all product specifications are accurate, customers must get confirmation of these before placing an order if they are important to the purchase. Miami Stainless will not be held responsible for any deviation in product specifications contained within this catalogue.

Quality: The stainless steel hardware you purchase from Miami Stainless branded as ProRig or Blue Wave comes from suppliers of only the highest quality products. Although these higher quality products are more expensive for us to buy, the end user will be more than satisfied with its long-term dependability. Not all 316 grade stainless steel is the same quality. We regularly test samples from other suppliers and find that dependable, trusted quality is hard to come by. Cheap stainless can end up being very expensive if it fails in an installation and you are required to replace all of your original work. As an installer of stainless products, you want a product that will not let you down. Miami Stainless is pleased to offer you dependable, trusted quality products from the ProRig and Blue Wave ranges at a reasonable price.

We also offer products from the ECON range. Whilst being a durable, usable product that satisfies the buyer needing to purchase based on a price point, the same high level of quality, usability and long-term satisfaction as the ProRig and Blue Wave ranges should not be expected.

Payment: Payment is required before we can dispatch your order. We accept Visa and MasterCard. You can also transfer the amount into our account via EFT - please provide a bank-generated remittance as confirmation of transfer.

Bank Details: WESTPAC - BSB: 034 238 - ACCOUNT: 174 217
ABN: 62 101 809 796

Delivery

For the most up-to-date shipping policy, please scan the QR code below to verify our delivery terms.



Happy with our service and products?

Leave us a review



Scan Me



MIAMI
STAINLESS

EXPECT QUALITY. EXPECT SERVICE - EXPECT VALUE

TO ORDER Visit www.miamistainless.com.au - Call 1800 022 122 - Email info@miamistainless.com.au



EXPECT QUALITY. EXPECT SERVICE - EXPECT VALUE

TO ORDER Visit www.miamistainless.com.au - Call 1800 022 122 - Email info@miamistainless.com.au